

OPTION

100345 - 01



211629 V02

1-2-3...

??

www.demeyeregroup.com

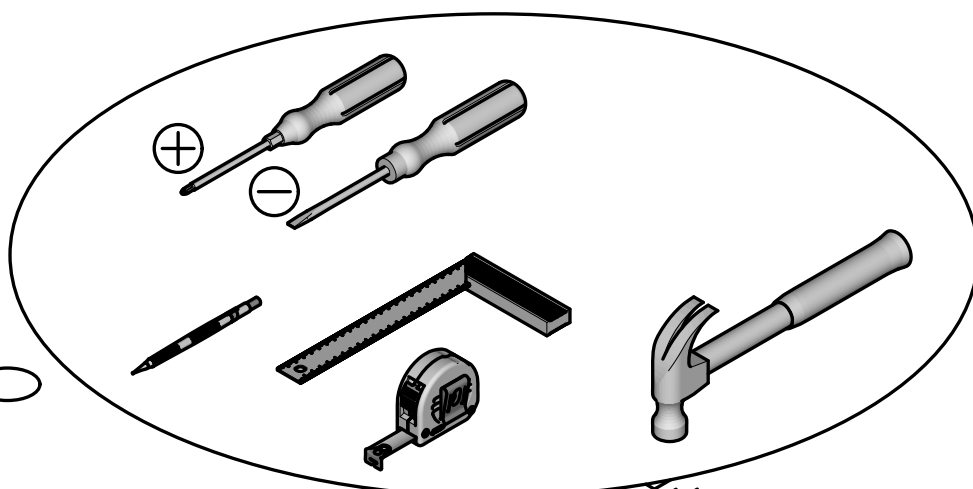
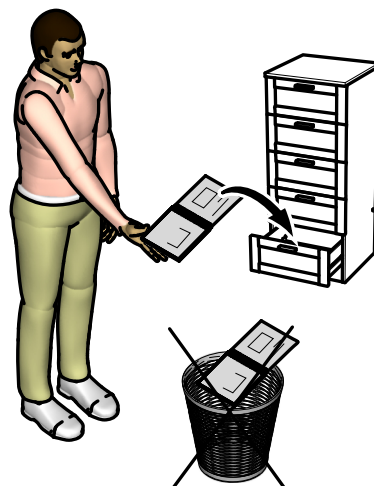

Donnez ou recyclez vos meubles.



Association

ou



Magasin

ou



Déchèterie

<https://quefairemesdechets.fr>

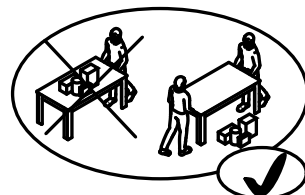
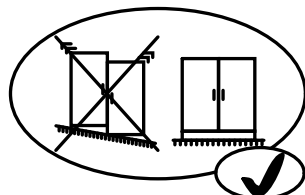
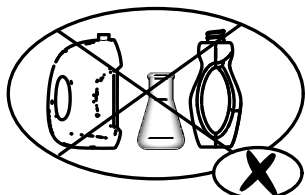

A x8

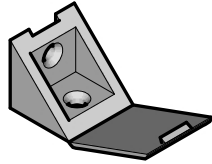

B x16



3,5x15mm
1/8"x 19/32"

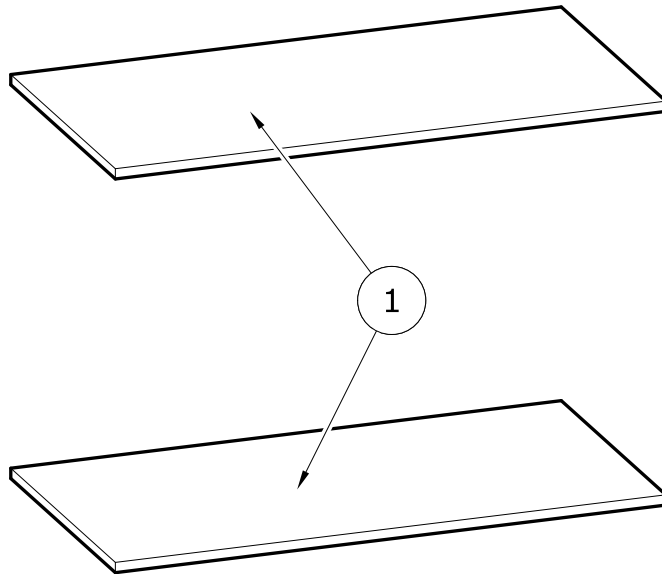
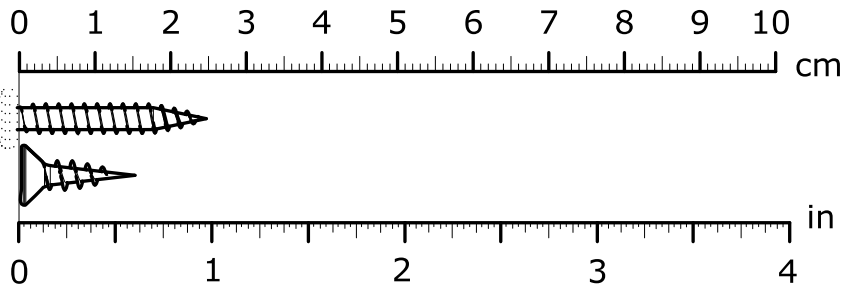

N°	MM			INCH			QTY
1	970	x	499	38 3/16	x	19 10/16	2

